



**25 Minutes**

## For Qi-Charger



**Professional Armrests Solutions For a Better Drive!**  
[www.armrest-systems.com](http://www.armrest-systems.com)

Tillverkare / Manufacturer / Hersteller:  
Sydmeko Industri AB, Santessonsv. 3, S-232 61 Arlöv, Sweden.  
Phone: +46 40 83640. Fax: +46 40 89090. E-mail: [office@sydmeko.se](mailto:office@sydmeko.se)

## PRE-INSTALLATION CAUTIONS/NOTES:

- DE** Beachten Sie bitte, dass bei Schäden in Folge unsachgemäßen Einbaus sämtliche Garantieansprüche erlöschen, insbesondere solche, die das Produkthaftungsgesetz betreffen.  
Das Recht zu Änderungen an Inhalt von Montagesatz und Einbauanleitungen ohne Vorankündigung bleibt vorbehalten. Lesen Sie vor dem Einbau diese Anleitung sorgfältig und gewissenhaft durch.  
Das Installationsverfahren in dieser Anleitung ist nur eine "Prinzip-Beschreibung", die deutlich zeigt, wie vorzugehen ist, um die Qi Aufladevorrichtung auf der 12V-Buchse im Auto zu installieren. Unterschiede zwischen Automodellen können vorkommen, weshalb wir immer auf das Servicehandbuch des Fahrzeugherstellers hinweisen, wo sie Informationen über die sichere und professionelle Zerlegung und der erneuten Zusammensetzung der Innenverkleidungen finden. Leiten und verstecken Sie die Kabel, sodass sie dem Sitz und dessen verschiedenen Einstellungen entsprechend beweglich sind.
- GB** We would expressly point out that assembly not carried out properly by a competent installer will result in cancellation of any right to damage compensation, in particular those arising by virtue of the product liability act. Contents of these kits and their fitting manuals are subject to alteration without notice, please ensure that these instructions are read and fully understood before commencing installation.  
The installation procedure in this manual is only a "principle description" that clearly shows how to connect the armrest Qi charger unit to the car's 12V outlet. Deviations between different car models may occur. Therefore, we always refer to the car manufacturer's service manual, where you will find information about how to dismantle and reinstall interior panels safely and professionally. Be sure to guide and conceal the cables in a professional and safe way, and allow the cables to move in accordance with the seat's various setting options.
- SE** Vi vill uttryckligen meddela att montering som inte görs fackmannamässigt av en kompetent montör, kommer att häva rätten till kompensation för skador, speciellt rättigheter enligt lagen om produktansvar.  
Innehållet i dessa satser och deras bruksanvisningar kan komma att ändras utan föregående meddelande. Vänligen läs dessa anvisningar noga innan du påbörjar monteringen.  
Monteringsförfarandet i denna anvisning är endast en "princip-beskrivning" som överskådligt visar hur man skall gå tillväga för att koppla in armstödets Qi-laddarenheten till bilens 12V uttag. Avvikelser mellan olika bilmodeller kan förekomma -därför hänvisar vi alltid till biltillverkarens service manual där ni finner information om hur interiörpaneler skall demonteras och återmonteras på ett säkert och yrkesmässigt sätt. Var noga med att leda och dölja kablarna på ett professionellt och säkert sätt samt tillåt kablarna att röra sig i enlighet med stolens olika inställningsmöjligheter.



LHD/RHD



-KOMponenten DER INSTALLATION FÜR Qi-LADERGERÄT AN JEDEM 12V SYSTEM  
 -COMPONENTS FOR INSTALLATION OF Qi-CHARGER TO THE CARS 12V SYSTEM  
 -KOMponenter FÖR INSTALLATION AV Qi-LADDARE TILL BILENS 12V SYSTEM

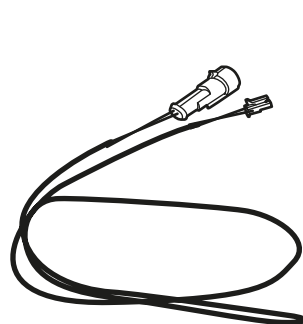

Cable B

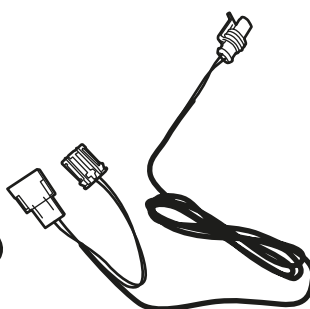

Cable C



Foam Piece

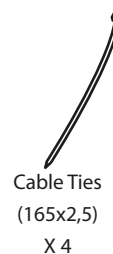

Cable Ties  
(165x2,5)  
X 4

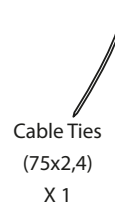

Cable Ties  
(75x2,4)  
X 1



Kit Contents

**LHD/RHD**

Left-hand drive shown  
- Same operation for  
Right-hand drive vehicles



Refer to



Proceed

## Installation Instruction Qi-wireless charger

- DE** Verwenden Sie die mit Bildern vorliegende Montageanleitung, um die Adapterhalterung auf dem Sitz zu montieren. Verwenden Sie diese Anleitung, um die Qi-Ladeeinheit zu installieren. Einige Elemente können parallel sein. Bitte lesen Sie beide Anleitungen sorgfältig, bevor Sie mit der Installation beginnen und beachten das Servicemanual der Fahrzeugherstellers beim Montieren und Abmontieren der Innenverkleidungen des Autos, um die Kabel zwischen der Armlehne und der 12V-Buchse im Auto Professional und ordentlich ziehen zu können.
- GB** Use the attached installation instructions with pictures to mount the adapter bracket on the seat. Use this instruction to connect the Qi charger unit. Certain moments may work in parallel. Please read both instructions carefully before starting assembly and consider using the car manufacturer's Service Manual as a guide to dismantling/installing the car's interior panels -in order to guide the cable between the armrest and the car's 12V socket in a professional and neat way.
- SE** Använd den bifogade monteringsanvisningen med bilder för att montera adapterfästet på stolen. Använd denna instruktion för att koppla in Qi-laddarenheten. Vissa moment kan verka parallellt så läs noga igenom båda instruktioner innan du påbörjar monteringen och tänk på att använda biltillverkarens Service Manual som vägledning för att demontera /montera bilens interiörpaneler för att kunna dra/leda kabeln mellan armstödet och bilens 12V uttag på ett yrkesmässigt och snyggt sätt.



ATTENTION



Refer to manufacturers official "service manual" for guidance how to remove/re-install parts



Switch off the cars ignition before you start the installation!



Make the installation in a warm car with indoor temperature



Follow the enclosed fitting installation and mount the car specific adapter according to the guidelines. Make sure it's been correct installed before you continue with this instruction and connect the Qi-charger to the cars 12V system.

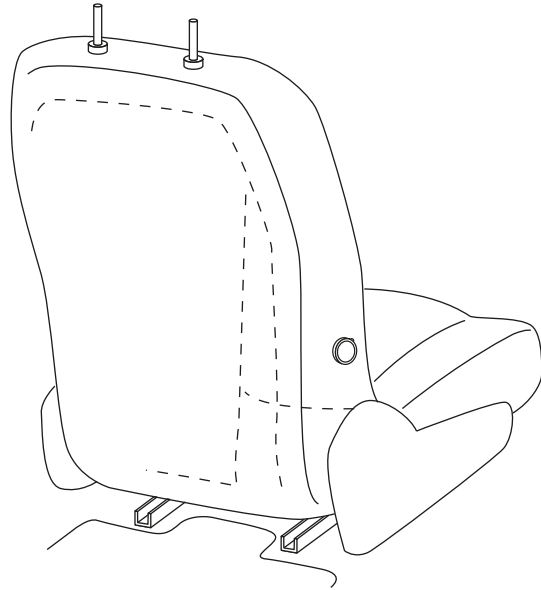

1



Guide/pull cable "B" from the lower backside of the seat frame, up and out to the side of the seat, next to the adapter bracket. Make sure the cable has a slack of minimum 12-13 cm so that you can connect it inside the armrest (showed in the next picture).

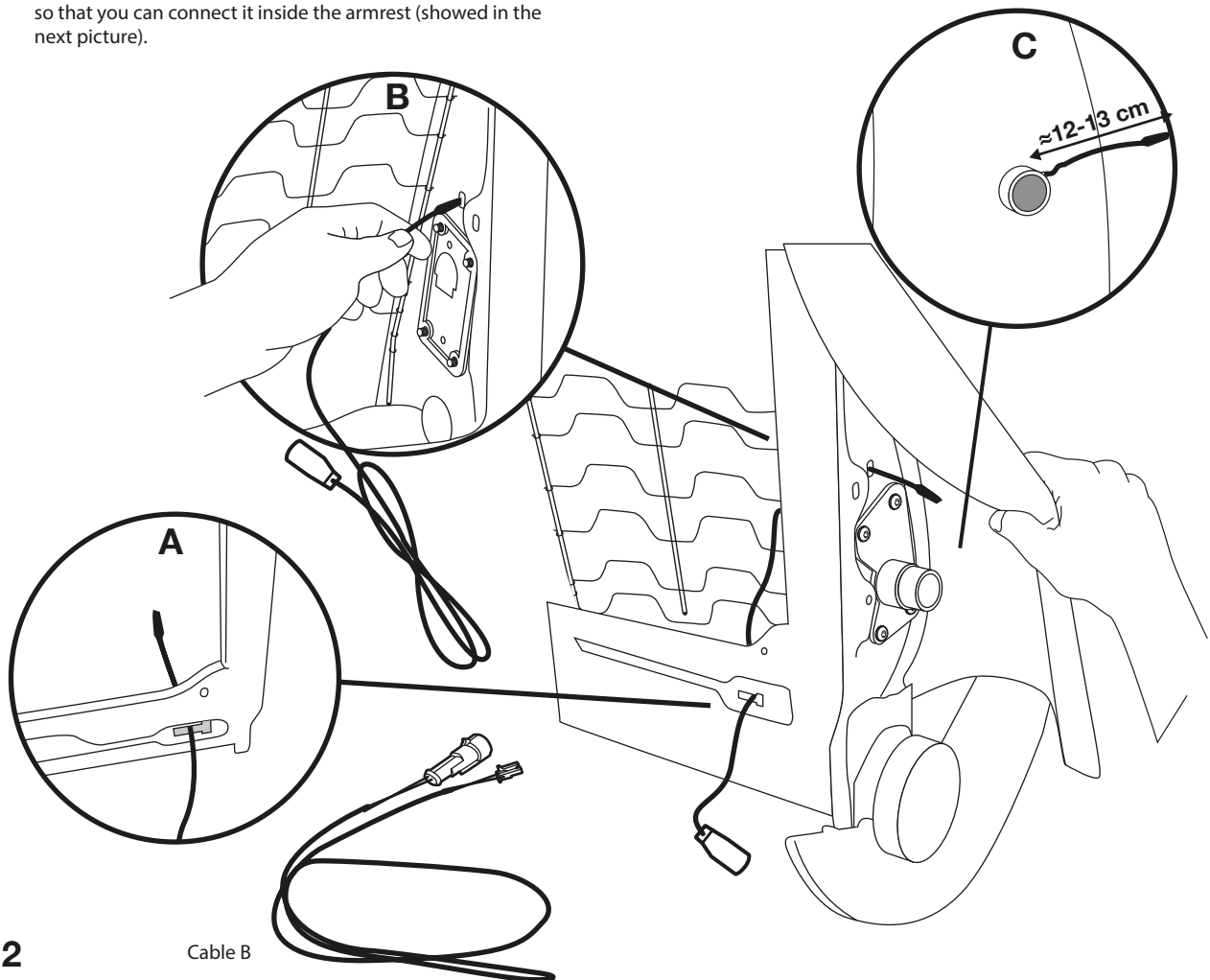

2

Cable B

## Installation Instruction Qi-wireless charger

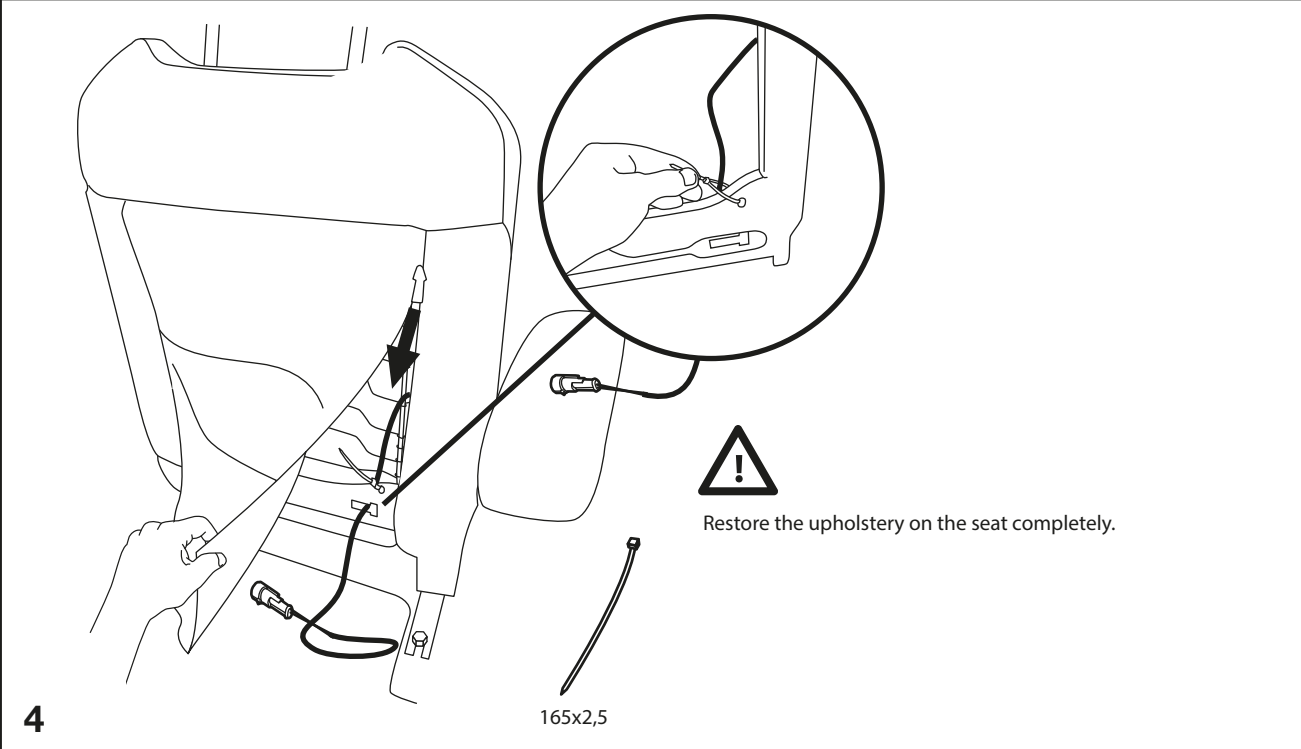
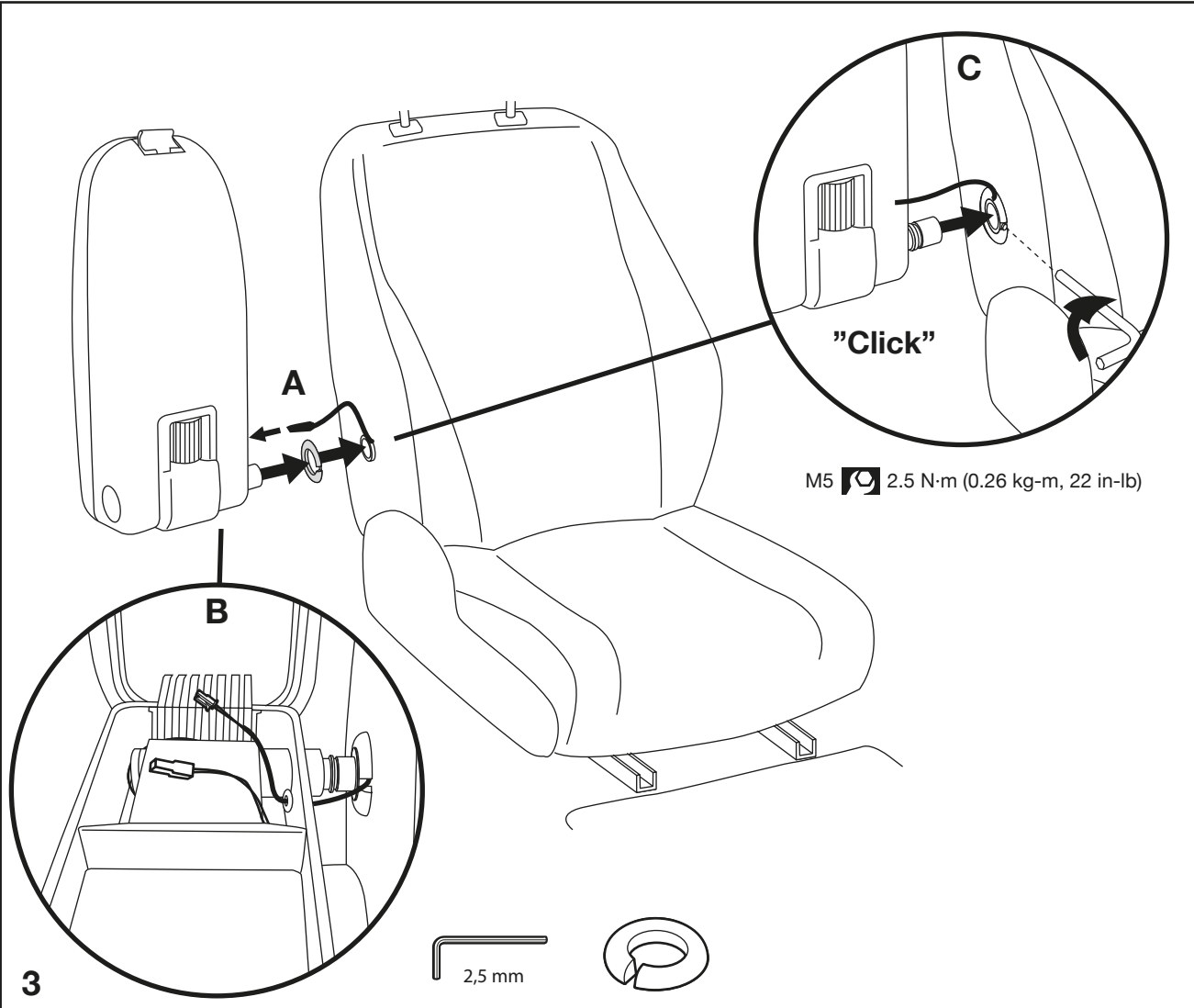

**Installation Instruction Qi-wireless charger**

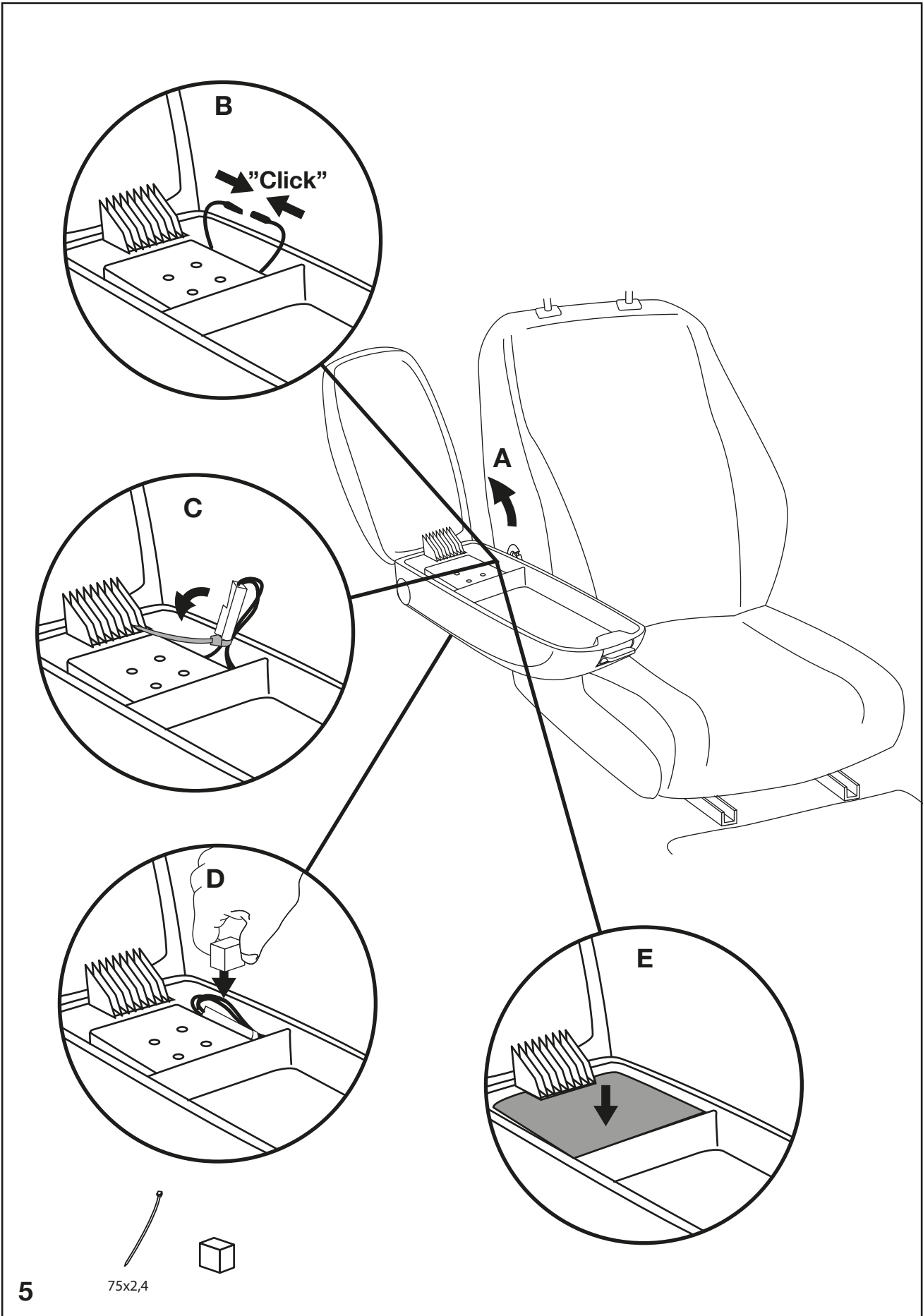

5

75x2,4

**Installation Instruction Qi-wireless charger**



ATTENTION



Locate where the nearest 12V socket is in the car. Then use the vehicle manufacturer's service manual for guidance how to loosen / disassembling the car's interior consoles -in order to be able guide/hide cable C into the car's 12V socket, in a safe and professionally way.

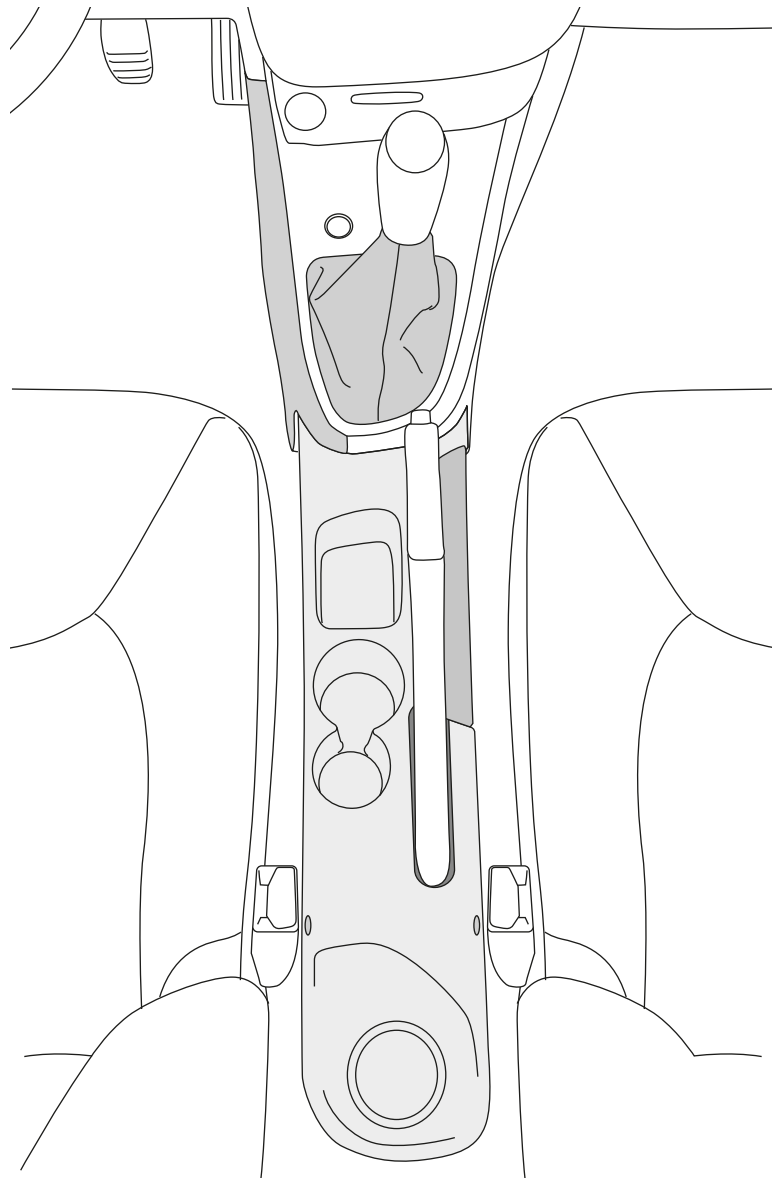

6



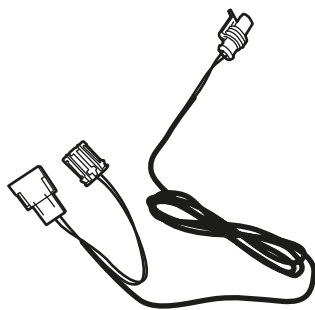
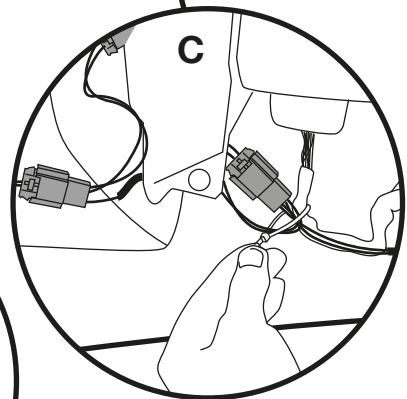
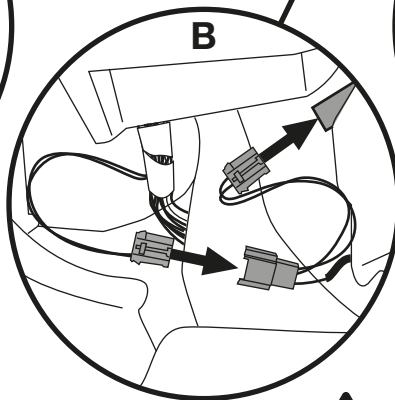
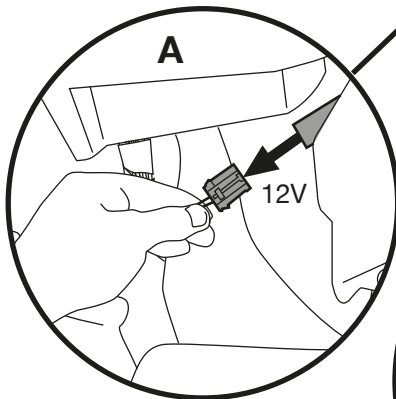
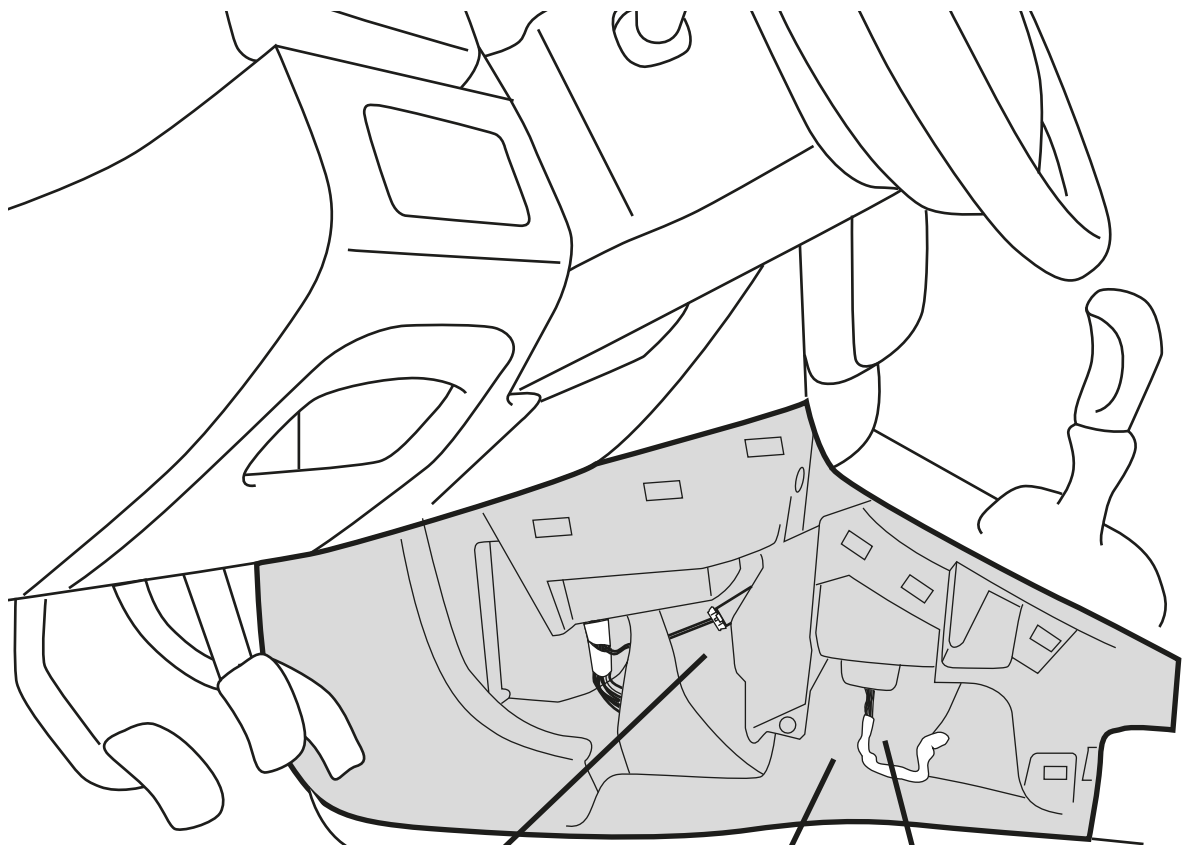

Connect Cable "C" as a "Bridge connection" on the back of the car's 12V outlet like the illustration shows:

- disconnect the original cable on the 12V socket.
- connect Cable C to the 12V socket
- Connect the original cable on Cable C
- Secure the cable slack with the enclosed cable tie strap.

**13** Cable C1

### Installation Instruction Qi-wireless charger

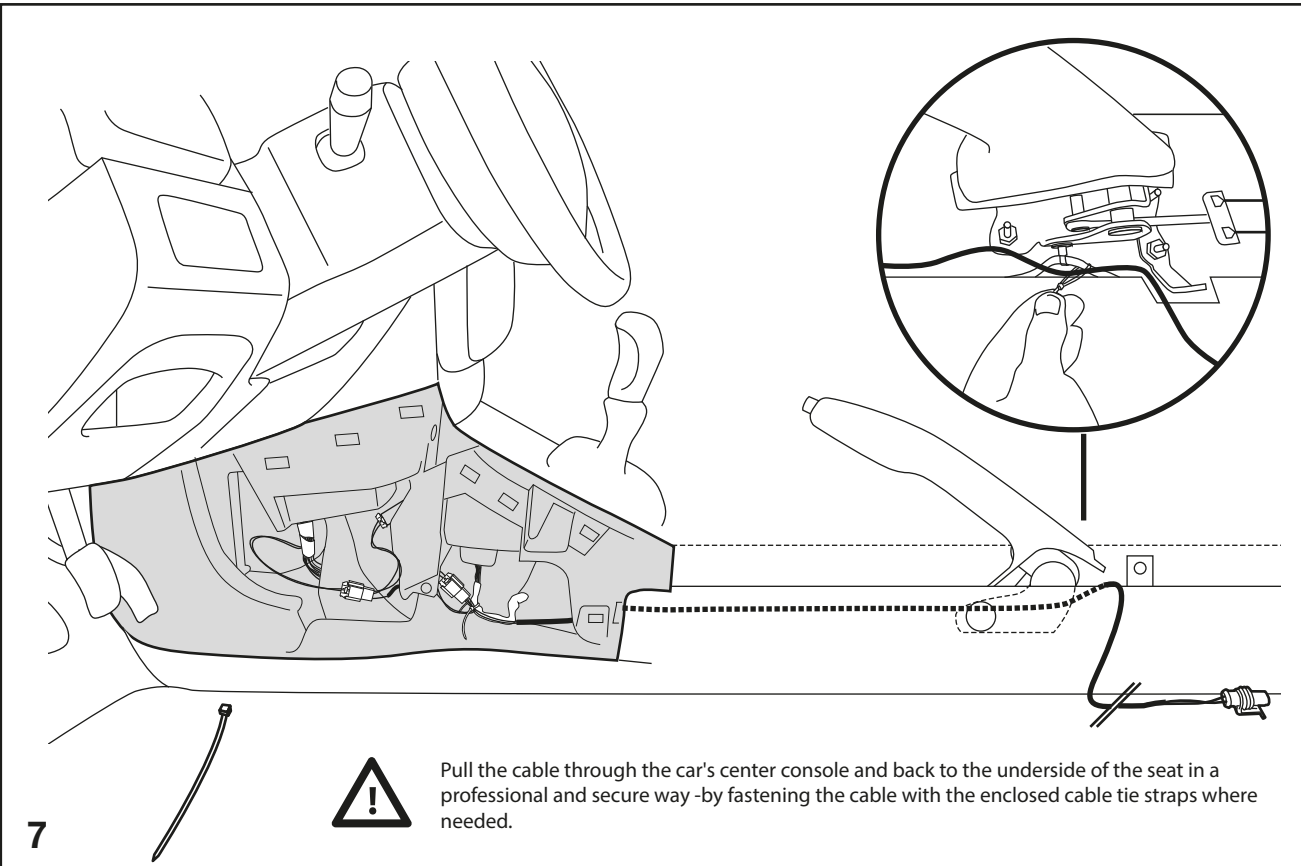

7



Pull the cable through the car's center console and back to the underside of the seat in a professional and secure way -by fastening the cable with the enclosed cable tie straps where needed.

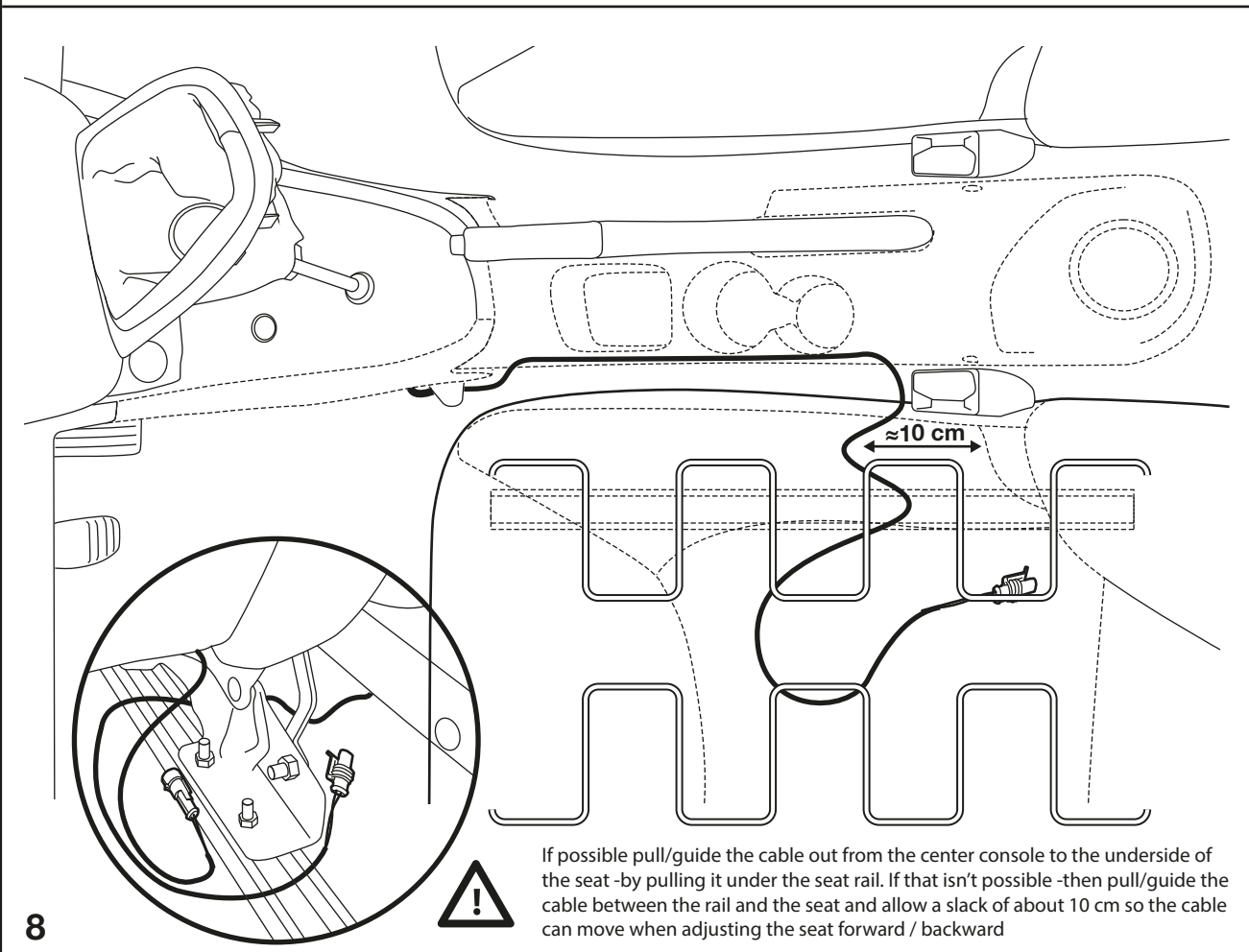

8



If possible pull/guide the cable out from the center console to the underside of the seat -by pulling it under the seat rail. If that isn't possible -then pull/guide the cable between the rail and the seat and allow a slack of about 10 cm so the cable can move when adjusting the seat forward / backward

**Installation Instruction Qi-wireless charger**



ATTENTION



Restore the center console and panels in the car by following the guidelines in the car's Service Manual.

9

### Cable A + B



Connect the cables and secure them under the seat. Allow a slack on the cable so that it can move with the seat!

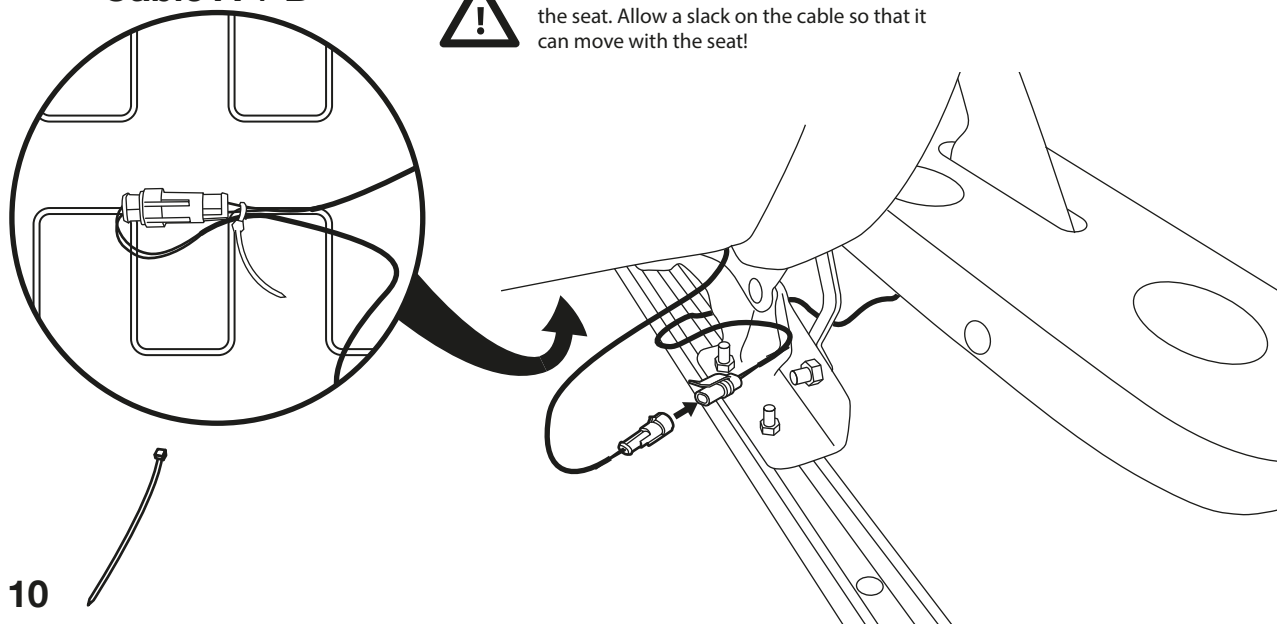

10

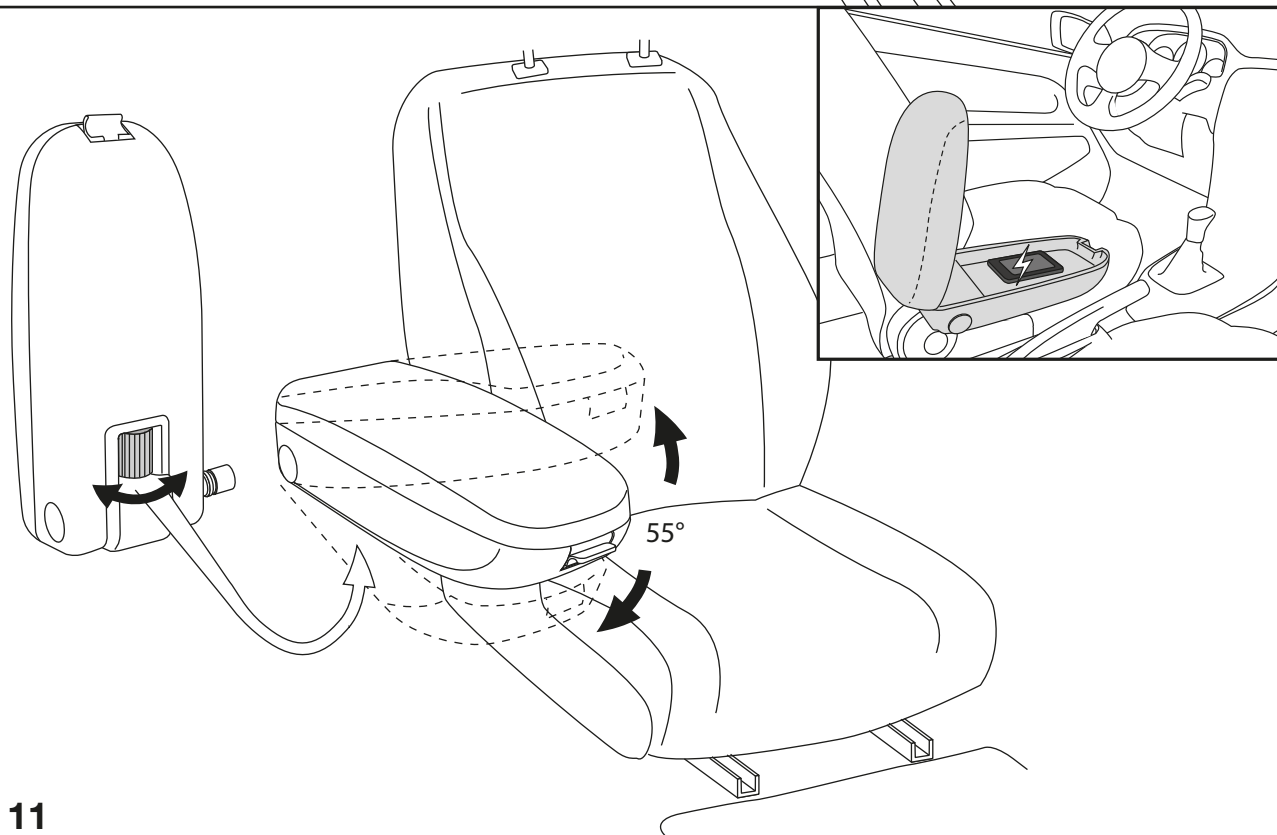

11

**DE**

**Bitte beachten** Sie, dass Sie ein Telefon mit eingebautem Qi-Empfänger benötigen, da sie sonst einen separaten „Qi-Receiver-Adapter“ für ihr Handy kaufen müssen. Um weitere Informationen über Qi zu erhalten, besuchen Sie bitte die Qi-Wireless Power Consortium Homepage unter:

<https://www.wirelesspowerconsortium.com>

Wir weisen Sie darauf hin, dass die Qi-Receiver für Handys bei vielen Web-Shops verfügbar sind, wie zum Beispiel: -www.amazon.com -www.ebay.com -www.acvgmbh.de -www.ikea.com

Suchen Sie nach "Qi-Empfänger" für Ihr spezielles Handy und stellen Sie sicher, dass der Empfänger mit dem offiziellen Qi-Logo gekennzeichnet ist, um eine stabile Verbindung zwischen dem Ladegerät und dem Empfänger zu gewährleisten.

#### **WICHTIGE INFORMATIONEN!**

**NICHT VERWENDEN, WENN SICH METALL-GEGENSTÄNDE (MÜNZEN ODER SCHLÜSSEL ETC) ZWISCHEN DEM DRAHTLOSEN LADEGERÄT UND DEM GERÄT BEFINDEN. DIE METALL-OBJEKTE KÖNNEN HEISS WERDEN UND VERBRENNUNGEN SOWIE DEFORMATIONEN DES GERÄTS VERURSACHEN.**

**FÜR AUTOS MIT EINEM KEYFOB / SMART-SCHLÜSSEL : BEWAHREN SIE BITTE DEN KEYFOB / SMART-SCHLÜSSEL NICHT INNERHALB DER REICHWEITE (10CM) DES Qi-CHARGER-MODULS WÄHREND SIE AM AUFLADEN SIND UND DAS KEYLESS ENTRY SYSTEM SCHARF GESCHALTET IST! SONST KANN EINE INTERFERENZ ZWISCHEN DEM KEYFOB / SMART KEY BEIM MOTOR START, BZW. BEI DEM ÖFFNEN UND SCHLIESSEN DER TÜR ENTSTEHEN. BITTE LESEN SIE IM TEXT UNTEN MEHR DARÜBER, WIE SIE DIESE PROBLEME MEIDEN KÖNNEN:**

#### **Zusätzliche Informationen über Keyfob / Smart Key Interference**

Keyfob / Smart Key-Interferenzen können auftreten, wenn der (smart) Schlüssel auf oder neben (in sehr engem Abstand) dem Qi-Modul platziert wird, solange dieses lädt und das Key System gleichzeitig ausgelöst wird. (durch Öffnen der Tür oder Starten des Autos). Das Problem kann gelöst werden, indem man den (Smart) Schlüssel weder auf ein gerade ladendes Handy, noch direkt neben das drahtlose Ladegerät platziert (solange es beim aufladen ist). Sobald der (Smart) Schlüssel von dem Qi-Modul entfernt wird, ist das Interferenzproblem gelöst und das Auto erkennt den (smarten) Schlüssel erneut.

**GB**

**Please note** that to be able to charge your phone with the Qi wireless charger you need to have a phone with a built-in Qi receiver -otherwise you need to purchase a separate "Qi-receiver adapter" to phones that don't have this built-in function. To get more information about Qi-wireless charging, please visit the Qi-wireless power consortium homepage at:

<https://www.wirelesspowerconsortium.com>

Please be aware that you can buy Qi-receivers to your phone on many available web shops on internet, such as: -www.amazon.com -www.ebay.com -www.acvgmbh.de -www.ikea.com

Search for "Qi-receiver" for your specific phone and make sure that Qi receiver is labelled with the official Qi-logo, in order to ensure a stable connection between the charger and the receiver.

#### **IMPORTANT INFORMATION / ATTENTION!**

**DO NOT CHARGE IF THERE ARE ANY METAL OBJECTS (SUCH AS COINS OR KEYS ETC) BETWEEN THE WIRELESS CHARGER AND THE DEVICE. THIS MAY CAUSE METAL OBJECTS TO BE BECOME HOT, RESULTING IN BURNS AND DEFORMATION OF THE DEVICE.**

**FOR CARS WITH A KEYFOB/SMART KEY -DO NOT PLACE THE KEYFOB/ SMART KEY WITHIN 10 CM OF THE Qi-CHARGER MODULE AS LONG AS IT'S CHARGING AND THE KEYLESS ENTRY SYSTEM IS TRIGGERED! OTHERWISE INTERFERENCE BETWEEN THE KEYFOB/ SMART KEY CAN OCCUR AT ENGINE START, DOOR OPENING AND CAR LOCK! PLEASE READ MORE ABOUT HOW TO OVERCOME THIS ISSUE IN THE TEXT DOWN BELOW:**

#### **Additional information about Keyfob/Smart Key Interference**

Based on the preferred installation position for the Qi modules in the selected cars, Keyfob/Smart key interference can occur when the (smart) key is placed on or next (in very close distance) to the Qi module as long as it's charging and keyless entry system is triggered. (eg by opening the door or starting of the car). The solution can be solved by placing the (smart) key not on a charging phone and not directly next to the wireless charger (as long as it's charging). As soon as the (smart) key has been taken away from the charging Qi module, the interference issue is solved and car recognizes the (smart) key again.

**SE**

**Observera** att du behöver en telefon med inbyggd Qi-mottagare för att kunna ladda din mobiltelefon i Qi-laddarenheten som är placerad i armstödet. För telefoner som inte har denna funktion inbyggd i telefonen behöver du en införskaffa en separat Qi-mottagare till din telefon. För mer information om Qi-trådlös laddning, besök gärna Qi-konsortiets hemsida på:

<https://www.wirelesspowerconsortium.com>

Observera att du kan köpa separata Qi-mottagare till din telefon på många tillgängliga webbutiker på internet, till exempel: -www.amazon.com -www.ebay.com -www.acvgmbh.de -www.ikea.com

Sök efter "Qi-receiver" för din specifika telefon och se till att mottagare enheten/produkten är märkt med den officiella Qi-logotypen, för att säkerställa en stabil anslutning mellan laddaren och mottagaren.

#### **VIKTIG INFORMATION!**

**LADDA INTE OM DET FINNS NÅGRA METALLFÖREMÅL (Ex MYNT, NYCKLAR ETC) MELLAN DEN TRÅDLÖSA LADDAREN OCH TELEFONEN. DETTA KAN BIDRA TILL ATT METALLFÖREMÅLEN BLIR VARMA OCH KAN ORSKAKA BRÄNNSKADOR ELLER DEFORMATION AV TELEFONEN.**

**FÖR BILAR MED EN KEYFOB/SMART KEY FUNKTION -UNDVIK ATT PLACERA KEYFOB/SMART KEY NYCKELN INOM 10 CM AV Qi-LADDAREN NÄR ENHETEN LADDAR OCH DET NYCKELLÖSA SYSTEMET ÄR AKTIVERAT. DETTA KAN ANNARS ORSAKA STÖRNINGS PROBLEM SOM RESULTERAR I SVÅRIGHET ATT STARTA BILEN ELLER ÖPPNA/LÅSA BILEN. LÄS MER I TEXTEN HÄR NEDAN HUR MAN SKALL AGERA OM OVANSTÅENDE PROBLEM INTRÄFFAR.**

#### **Ytterligare information om Keyfob / Smart Key Interference**

Baserat på den föreslagna installations platsen för Qi-laddaren i den valda bilen, kan störning av bilens Keyfob/Smart-Key system uppträda när/om man placerar bilnyckeln/nyckelkortet direkt på Qi-laddaren eller telefonen (eller i direkt närhet av dessa) -när laddning pågår och det nyckellösa systemet är aktiverat (ex vid dörröppning eller vid start av bilen).

Om detta problem skulle inträffa löser man det enkelt genom att avlägsna bilnyckeln/nyckelkortet från Qi-laddaren (eller från direkt närhet av denna) när laddning av telefonen pågår. Så snart detta är gjort återställs bilens smarta nyckel och återgår till sin normala funktion igen.

## **Installation Instruction Qi-wireless charger**